

Bischoff & Bischoff

Instruction manual

S-Eco 300



Enjoy mobility.

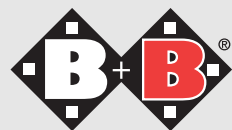

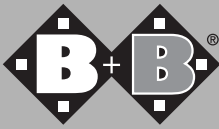

Content

1	Introductory remark	4
	1.1. Signs and symbols	
2	Important safety measures	6
	2.1. General safety measures	
	2.2. Brakes	
	2.3. Anti tipping wheels	
	2.4. Set of tyres	
	2.5. Obstacles	
	2.6. Ascending slopes & downward slopes	
	2.7. Using public paths and streets	
	2.8. Purpose	
	2.9. Indications	
	2.10. Contraindications	
	2.11. Responsibility	
	2.12. Declaration of conformity	
3	Product and delivery overview	13
	3.1. Delivery check	
	3.2. Scope of delivery	
4	Handling/Use of the wheelchair	15
	4.1. Setting up of the wheelchair	
	4.2. Folding the wheelchair	
	4.3. Getting on and off the wheelchair from the side	
	4.4. Getting on and off the wheelchair from the front side	
	4.5. How to surmount stairs and high steps	
	4.6. Footrest	
	4.7. Leg support	

4.8. Tipping aid	
4.9. Side parts	
4.10. Handbrakes	
4.11. Seat height	
4.12. Drum brake (optional)	
4.13. Anti tipping rolls (optional)	
4.14. Lap belt (optional)	
5 Technical Datas	27
6 Transport	28
6.1. Transporting the wheelchair	
6.2. Seat in disabled vehicle	
7 Maintenance instructions for the user	34
7.1. Cleaning	
7.2. Wheelchair check by the user	
8 Repair instructions and maintenance instructions	36
9 Disposal	37
10 Passing on/transmission of the wheelchair	37
11 Maintenance	37
12 Guarantee	38
13 Guarantee – Certificate	39

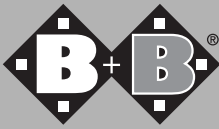

1. Preliminary remark

Dear user,

You have chosen a high quality wheelchair by Bischoff & Bischoff. We thank you for your trust in our product.

The wheelchair was designed in such a way to offer you many advantages and to meet all your needs. Due to its various adjustment features the S-Eco 300 wheelchair can be adjusted in seat width, seat angle and lower leg length to your individual body sizes.

The S-Eco 300 wheelchair can be used both indoors and outdoors.

Before you start using your new wheelchair for the first time, make sure you read the operating instructions carefully. It is a very important and necessary part of your wheelchair. Keep the operating instructions ready at hand and when you pass on your wheelchair to someone else please ensure to pass on the instructions.

Repairs and adjustments require a special technical knowledge and therefore can be carried out only by specialists which are authorised by Bischoff & Bischoff.

1.1. Signs & Symbols

You have chosen a high quality wheelchair by Bischoff & Bischoff. Thank you for your trust in our product.



Attention! This sign is used for very important parts concerning your safety. Please look at the operating instructions.



Important! Indicates very useful information on the respective matter.

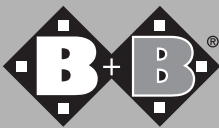

2. Important safety measure

2.1. General safety measures

Before you start using your wheelchair please make sure that all parts are well secured.

In order to avoid any accidents and dangerous situations practice using your wheelchair on flat and clear ground. It is recommended to have a companion in this case.

The wheelchair must not be misused to transport more than one person or to carry any loads. Pay attention to its purpose.

Never use the wheelchair under the influence of alcohol or other drugs which affect your concentration or physical and mental perceptive faculty.

Please observe that by shifting the balance through body movements or by loading the wheelchair, the risk of tipping over can be increased.

Please observe that the upholstered parts which have directly been in contact with sunrays are heated and can cause injuries to your skin. Therefore you should cover these parts or keep your wheelchair out of the reach of sunrays.

For rides outdoors you should wear leather gloves. They increase your grip and at the same time protect your hands from dirt and injuries.

Be careful when setting up your wheelchair and pay attention to your fingers. There is a danger of trapping your finger. Look at the chapter referring to unfolding your wheelchair.

2.2. Brakes

The brakes which work directly on the tyres can be used just as handbrakes, i. e. they should only be used when the wheelchair is in standing position and not to lower its speed.

When braking down on fast rides or on long slopes using the grab wheels (Greifreifen) your fingers and palms get hot. Attention! Danger of burning!

2.3. Anti tipping wheels (optional)

The anti tipping wheels prevent the wheelchair tipping over. Please observe that driving with anti tipping wheels on areas with stairs, hydraulic ramps and ramps is limited. Make sure there is enough space above, below and on both sides.

2.4. Tyres

Always observe that the tread depth of your tyre is satisfactory (> 1 mm). If the tread depth is insufficient, it is no longer possible to assure safe performance of your wheelchair.

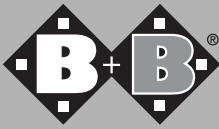

2.5. Obstacles

To surmount obstacles (e.g. kerbstones, steps, etc.) please always use loading ramps.

Avoid driving against obstacles without braking or bumping down from a higher level.

2.6. Ascending slopes & downward slopes

Please do always consider that on extreme adjustments of your drive wheel your wheelchair may tip over backwards at just a slight slope. Use your wheelchair with extreme adjustments only accompanied by another person. Also use the anti tipping rolls to avoid tipping over backwardly.

2.7. Using public roads & streets

The wheelchair was designed to be used both indoors and outdoors. When using it in the road, road traffic regulations must be obeyed.

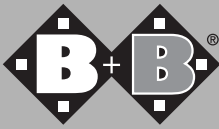

2.8. Purpose

The wheelchair was exclusively designed to increase mobility and transport of people who have a walking disability according to the mentioned indications.

The maximum weight capacity is 125 kg.

2.9. Indications

Walking disability or distinct walking impairment due to:

- paralysis
- extremity loss
- extremity defect/deformation
- joint stiffness/damage (not on both arms)
- Other diseases.

2.10. Contraindications

It is improper to use the wheelchair if there is

- a perception disorder/ perceptual disturbance
- a disturbance of equilibrium
- extremity loss on both arms
- joint stiffness/damage on both arms
- Sitting incompetence
- Reduced or insufficient eyesight

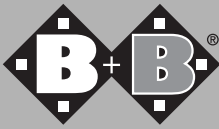

2.11. Responsibility

We can only ensure safety if the product is used under the given conditions and for the mentioned purposes. Changes, enlargements, repairs and maintenance jobs can be carried out only by authorised people. When using the wheelchair you must obey all operating instructions.

2.12. Declaration of conformity

The producer Bischoff & Bischoff certifies in its role as the producer its sole responsibility that the wheelchair S-Eco 300 corresponds to the 93/42 EWG directive.

3. Product & delivery overview

3.1. Delivery check

The wheelchair S-Eco 300 is delivered in a cardboard packaging and is ready for use. After unpacking please retain the cardboard packaging if possible. You may need it later for storage or for the return of the wheelchair.

The delivery and the introduction to the wheelchair are carried out by qualified and authorised medical companies.

When dispatching the wheelchair by train or carriage it has to be checked immediately after arrival in the delivery person's presence in order to confirm the safe delivery of the product. In the unlikely case that there has been some damage immediately contact our customer service number: (+49 (0)700/6000 7070).

Check the content for completeness and intactness. If there are irregularities or damages do not hesitate to call our customer service number (+49 (0)700/6000 7070).

3.2. Scope of delivery

The content consists of the following main components:

- preassembled wheelchair
- 1 pair of leg support
- 1 calf belt
- 1 booklet of operating instructions
- 1 pneumatic pump (only with pneumatic wheels)
- 1 set of tools

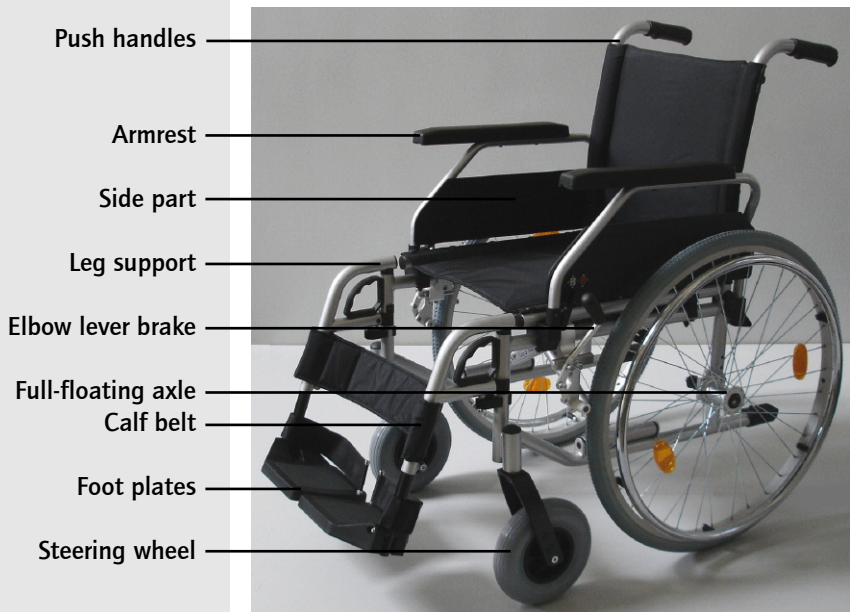

Fig. 1

4. Use of the wheelchair

4.1. Setting up the wheelchair

In order to unfold your wheelchair after having unpacked it, take a place next to the wheelchair.

- Seize the armrest or the seat pipe with one hand on one side of the wheelchair and tilt it towards yourself.
- Push with your other hand the cross brace apart until the seat pipe is completely set in the plastic holder.
- The seat cushion must be completely spread out.
- Use the handbrake on the left and on the right of the driving wheels.
- Hook in the leg support
- Now you can sit on your wheelchair.

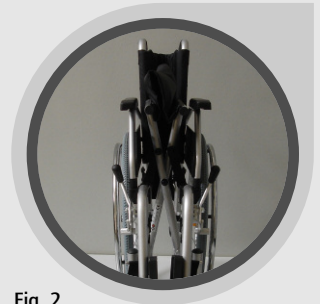

Fig. 2



Fig. 3

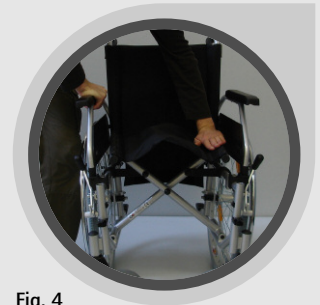

Fig. 4



Fig. 5



Fig. 6

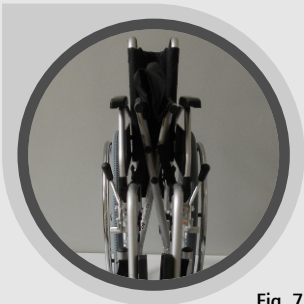

Fig. 7

4.2. Folding the wheelchair

In order to fold your wheelchair, first elevate the footplates.

- Stand next to the wheelchair.
- Take hold of the seat cushion at the front and back and pull it up. In order to load the wheelchair into your car you can remove the rear wheels gently over the full floating axle.



Danger of trapping your finger!
Be careful not to grasp the seat pipe

4.3. Getting on & off the wheelchair from the side

- Put the wheelchair as close as possible next to the present or future seating surface.
- If you want to change seats from another wheelchair or undercarriage first make sure to use the hand brakes
- Secure the S-Eco 300 wheelchair to avoid unwanted moving by using the brake lever on the left and right side of your wheelchair.
- Swing the padded armrest backwards.
- Fold the foot plates on the side or remove the leg supports.
- Slip at the side to the other seat.
- Make sure you sit as far back in your seat As possible
- Finally place the leg support back in the initial position.

4.4. Getting on & off the wheelchair from the frontside

- First swing the foot plates up or remove the leg support.
- Put the S-Eco 300 wheelchair as close as possible to the future sitting accommodation in frontal position.
- If you want to change seats from another wheelchair or undercarriage, first make sure to use the hand brakes to secure it.
- Now slip by turning your body on the seating surface.
- Finally you place the foot support back in its initial position.



Never climb on the foot plates!
Danger of tipping over!

4.5. How to surmount stairs & high steps



If the stairs are high and if there are stairs with more than 3 steps, 2 people must carry the wheelchair.

- The helpers must only take hold of firmly mounted frame sections. (picture 8 and 9)
- While ascending stairs the helper behind the wheelchair pulls the wheelchair over the step holding it on the fastened grips.
- The helper who is at the bottom/below takes hold of the front frame pipes and stabilises the position. While he is doing so he pushes the rear wheels of the wheelchair against the steps.



Fig. 8

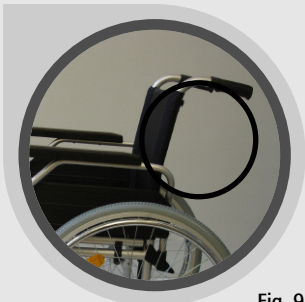

Fig. 9

- When descending the stairs the helper who is below, brakes by pressing the wheelchair straight onto the steps. The helper who is above takes hold of the wheelchair at the push handles, secures it and holds it in the right position. The wheelchair should roll step by step down the stairs.



The holding points for transportation of the wheelchair are exclusively the frames and the push handles. The armrests mustn't be used for lifting the wheelchair under no circumstances.

4.6. Foot plates

- The length of the leg support can be directly adjusted for 12 cm.
- To do this you have to undo the socket-head cap screw (SW 5)
- Adjust the leg support height according to your choice.
- To get on and off the wheelchair you have to tip up the footplates on the side



Attention!
The maximum extension length is marked.



Fig. 10



Fig. 11



Fig. 12

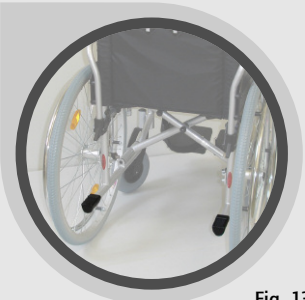

Fig. 13

4.7. Leg support

- To make it easy for you to get on and off the wheelchair you can fold up the foot plates or swing the leg supports outwardly or pivot them upwardly and take them off.
- To swing the leg supports outwardly open the locking device.
- Being in the "outward position" the leg support can be taken off completely.
- To assemble the leg supports proceed in reverse order.
- Swing the leg supports back to the front position until they snap in clearly audible.

4.8. Tipping aid

- Thanks to the tipping aid the accompanying person can tip your wheelchair much easier to for example cross over a step.
- To do it you have to press down a lever with your foot. You keep your balance by holding the push handles.
- The tipping aid juts out on the left and right side of the frame and is equipped with rubber profiles to grip well.
- There is also the option to assemble anti tipping rolls instead of the rubber profiles.

4.9. Side parts

- To make it easier to get on and off the wheelchair both side parts with the armrests can be swung backwards.
- Use the lock device lever pressing it gently with your finger and at the same time swing the side part backwardly.



Never use the side parts to carry the wheelchair!

- To lock the side part fold it forward and with a gentle push let it snap in the armrest



Make sure that while you pivot the side parts no garments or implements can be caught. Before putting the wheelchair into operation for the first time check whether the side parts are tightened well.

- The arm support for the side parts (desk/long) are short mounted at delivery.
- The readjustment to long is carried out by rotating the arm support 180 ° and mounting it on the opposite side part.(picture 16)

4.10. Hand brakes

The S- Eco 300 wheelchair is equipped with a handbrake which can be used by the user of the wheelchair. It should be only used for parking. It is not suitable for braking during a ride! To brake you use your palms to make a weak pressure on the grab wheel.



Fig. 14



Fig 15



Fig. 16



Fig. 17



Fig. 18

After you have put the brakes on in this way you use both brakes pulling the brake handle forward. The wheelchair has now been safely stopped.

- The distance between the pivot bolt and the outer tyre cover at maximum open brake mechanism/device has to be $x = 15 \text{ mm}$ at the narrowest part.
- To adjust the distance you have to remove the two hexagon socket screws at the brake mounting (underside/bottom) Picture 18
- Then you pull the brake system along the mounting in the correct position.
- The pivot bolt must be horizontal e.g. parallel to the underground
- Finally you have to tighten up again both hexagon socket screws.
- Make sure that the brake snaps in when you use the brake lever and that it does not snap back.



The brake adjustment should be carried out by trained experts. However if you have enough experience you can do the job yourself. But consider that wrongly adjusted brakes can have life-threatening consequences.



In order to ensure optimal brake functioning pneumatic wheels should have a pressure of 300-400 k Pa (3-4 bars). If the air pressure in the tyres is not according to the regulations then there is a danger of brake function loss.

4.11. Seat height

The seat height can be adjusted to 3 positions to meet the needs of the user.

The drive wheel and the steering wheel have to be at the same position each time.

AT THE TOP – MIDDLE – AT THE BOTTOM

Drive wheel:

- Remove the drive wheels by means of the full-floating axle.
- Unscrew the screws at the adapter (hexagon socket, SW 4 and ring spanner SW 10) and pull it out completely.
- Align the adapter to the desired seat height
- Put the screws back in the adapter and tighten them firmly.



Align the steering wheel to the same hole position as the driving axle. Only this assures a directional stability.

Steering wheel:

- First remove the facing of the optional drill holes.
- Unscrew the axle (hexagon socket, SW 4) and take it out completely.
- Align the steering wheel to the desired seat height.
- Put the axle back in the steering fork and tighten it firmly.

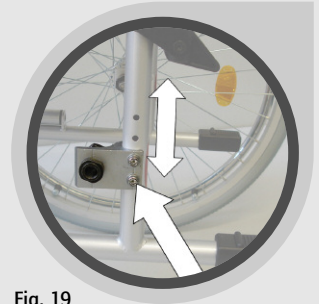

Fig. 19



Fig. 20



Fig. 21

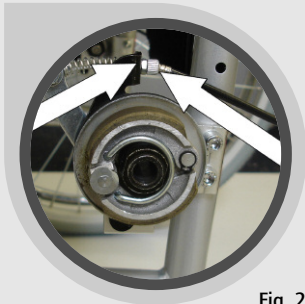

Fig. 22

4.12. Drum brake (optional)

The S-ECO 300 can be equipped with a drum brake which can only be used by the accompanying person via the brake lever on the push handle. The drum brake can be used both as a handbrake as well as a driving brake. As a driving brake it enables regulated braking. The hand brake function is used for parking purposes.

- To use the brake you have just to pull the brake lever and to push up the stopping lever.
- To let off the hand brake you just have to pull the brake lever shortly. (The locking device loosens automatically.)
- To achieve optimal braking efficiency the braking power is adjusted at the adjusting screw. The braking efficiency can be amplified by decreasing the screw bolt and it can be decreased by increasing it.
- Please decrease the adjusting bolt until you can hear a grinding noise.
- Increase the adjusting bolt again until all the noises disappear. The wheel runs well then.
- After finishing the adjustments the adjusting bolt is fixed by a counternut.

4.13. Anti-tipping rolls (optional)



Always use the anti-tilt mechanism in pairs.

The anti tipping rolls prevent that your wheelchair tips over. The wheel must have a distance of 3- 5 cm from the floor. The anti tipping rolls are especially recommendable for wheelchair drivers without any practice or for those wheelchair drivers who have amputated a leg.

- The anti tipping rolls go in pairs and are fastened left and right on the frame.
- First detach the rubber profiles of the tilt aid from the frame.
- Push the round profile of the anti tipping rolls on the side frame pipe.
- Now bolt the tilt protection with a screw M 6 x 35 and a self-locking nut M6 in the designated drilling on the frame.



Fig. 23



Fig. 24

4.14. Lap belt (optional)

A lap belt can be ordered optionally and secures users who do not have enough support in the wheelchair.

- The S-Eco 300 wheelchair can be equipped with a safety belt at the back pipe.
- The belt is opened and closed with a fastening clip.
- You can adjust the belt length with the moveable belt clip on the belt.

5. Technical data

Measures/dimensions & weights

Maximum weight capacity (kg):	125
Seat width (cm):	37/40/43/46/49/52
Seat depth (cm):	42
Frontal seat height (cm):	47/49/51
Seat angle (°):	3, 8
Total width:	seat width + 19 cm
Total length with/without Leg support (cm):	99/77, 5
Total height (cm):	87/89/91
Backrest height (cm):	40
Lower leg length (cm):	30 up to 42 (without gradation)
Backrest angle (°):	5 (without adjustments)
Foot rest angle (°):	15 (without adjustments)
Knee angle (°):	115 (without adjustments)
Armrest height (cm):	22
Armrest length (cm):	34
Unloaded weight (kg):	from 19, 0
Frame weight (kg):	10, 5
Dimensions in folded state (L/W/H) cm:	101/33/91

Wheels

Drive wheels (inch):	24 x 1 ³ / ₈ " (breakdown secure)
Steering wheels (cm):	Ø 200 x 50 mm (breakdown secure)

6. Transport

6.1 Transporting the wheelchair

To make the wheelchair as convenient as possible to transport, all detachable parts (footrests, wheels, slot-in accessories) must be removed and the wheelchair folded.

6.2 Seat in disabled vehicle

You can check whether your wheelchair is licensed as a seat in a disabled vehicle by the symbols on the frame (Fig. A and Fig. B).

All wheelchairs authorised by B+B as seats for use in vehicle are tested to ISO 7176-19: 2008.

- The securement points are marked with a symbol (Fig. A). Other attachment points are not authorised by the manufacturer.
- Where possible, use a fixed fitted car seat and its seat-belt system. Stow the folded wheelchair in the boot.
- The person responsible for transportation should be familiar with the current regulations on transportation and use of the disabled vehicle and restraint system.
- 4-point restraint systems anchored to the vehicle must be used to restrain the wheelchair.



Fig. A: Wheelchair suitable as seat in disabled vehicles / anchor points



Fig. B: Wheelchair not suitable as seat in disabled vehicles

- Detachable parts and accessories on the wheelchair, such as trays and bags, should, where possible, be removed and safely stowed in the boot. If attachments are not detachable they must be folded away and secured by the user or adequately padded.
- When used as a seat in a disability vehicle, a 3-point safety belt must always be worn. Other fixation systems and straps may be used in addition.
- If your wheelchair has an adjustable backrest or seat, these must be placed in as vertical a position as possible and the locking mechanism checked.
- Products that have been involved in an accident must be replaced and are no longer licensed to transport people.

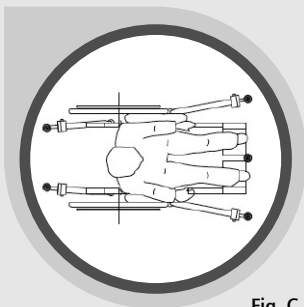

Fig. C

Positioning of wheelchair

- Position the wheelchair facing forwards (Fig. C).

Check whether the straps conform to the angles in Fig. D.

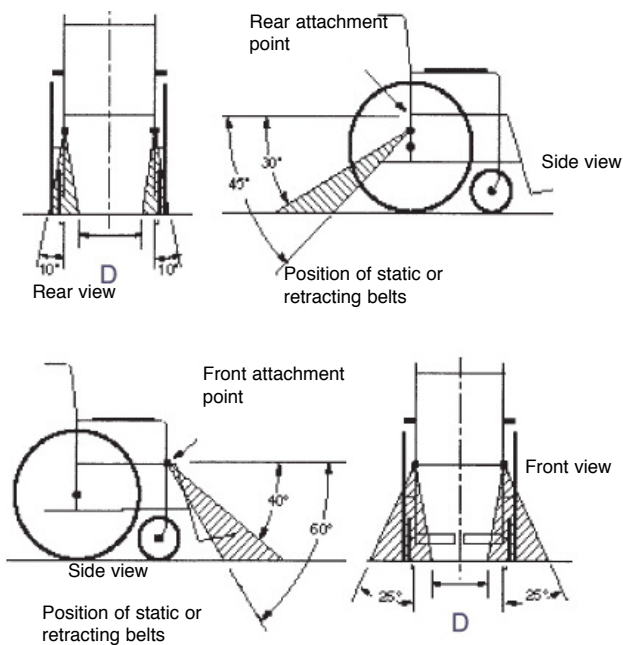

Fig. D

- Stipulated angles and positions of straps from wheelchair to vehicle floor. Front straps should be arranged so that the angle ensures optimum lateral stability ($D = 300\text{mm}$).
- The hatched area indicates the range within which the straps must be attached to the floor!
- Wheelchair must not be placed in front of an active air-bag Deactivate air-bag or have it deactivated!

Attachment to vehicle floor

Rails (Fig. E)

Insert fitting into rail at an angle and then pull in side-ways. Detach the fittings by pulling on the snap ring.

Mono System (Fig. F)

Place mono-fitting flat on the base plate and pull over the base plate. Detach the mono-fittings by pulling down from the base plate.

Attachment to wheelchair

Attachment to the wheelchair may be by securement points (Fig. G) or tie-down system (Fig. H) to the labelled points.

Under no circumstances attach the strap to the footrests or other detachable parts.

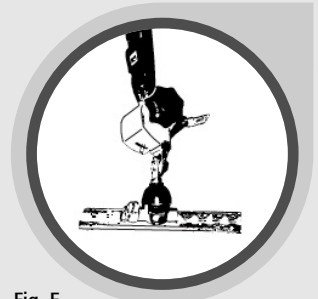

Fig. E

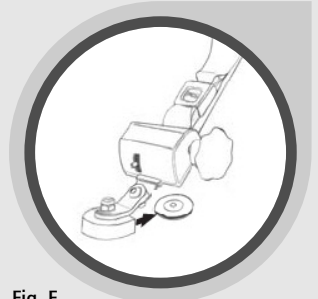

Fig. F

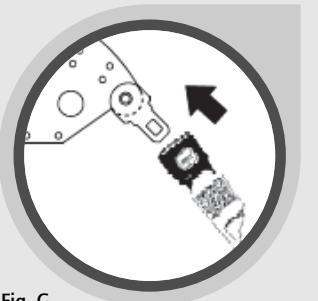

Fig. G

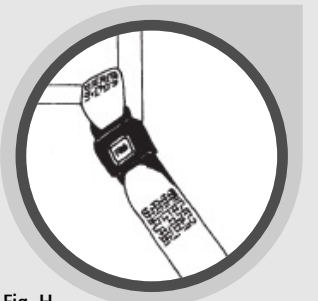

Fig. H

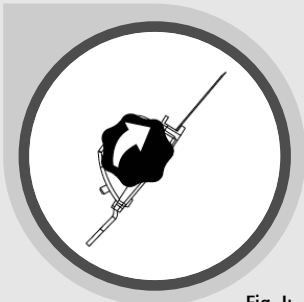

Fig. I:
open



Fig. J: close

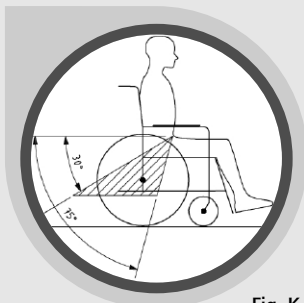

Fig. K

Tensioning and loosening the straps

- Tension using handle (Fig. I)
- Loosening using lever or alternatively by releasing the belt tongue from the belt buckle (Fig. J).

Safety belt

The safety belt must run at an angle of between 30° and 75° to the horizontal (Fig. K), with a larger angle being preferable. It must fit low on the pelvis.

Make sure that the belt lies flat and is not twisted at any point.

The lap belt must be attached on both sides to the rear securement points. To close the lock, insert the tongue into the buckle. It clicks into place. The lock is opened by pressing the large button.

The safety belt should fit firmly but not cut in. To tighten the belt pull on the loose end of the belt. You can further adjust the belt by pushing the clasp forwards in the open position.

The shoulder belt hooks into the lap belt. It must fit close to the body across the pelvis, chest and over the shoulder.

Place the clasp in front of the occupant's body, not on the pelvic bone! The clasp must be positioned in such a way that, in the event of an accident, it cannot be accidentally released by attachments.

Belts must not run across wheelchair attachments such as armrests or wheels! (Fig. L & Fig. M)

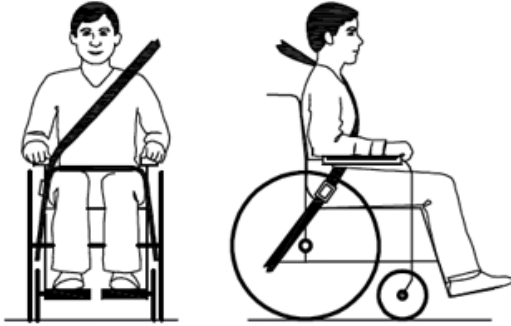

Fig. L

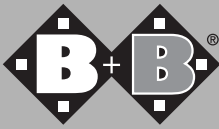

Fig. M

In order to be able to remove the belt quickly in the event of an accident, a seat belt cutter like this (Fig. N) should be kept in every vehicle.



Fig. N



7. Maintenance

instructions for the user

7.1. Cleaning

- The frames of the wheelchair can be cleaned with a damp cloth. If there is more dirt you can use a mild cleanser.
- The wheels can be cleaned with a damp brush made of synthetic bristles (do not use wire brushes)
- The seat and back upholstery can be washed at 40 °C. Use mild washing powder. For disinfection add a usual disinfectant to the rinse cycle which will kill all bacteria and germs at the washing temperature of 40 °C.



Do not use any pressure washers or steam cleaners.

7.2. wheelchair check by the user

Before you use your wheelchair to have a ride check

- the intactness of the wheels. You should regularly check the profile depth of your wheels once a month. The profile should be at least 1 cm. Faulty or worn out wheels must be changed.
- the functional efficiency of the handbrake. When you pull your brake the wheelchair should remain still. When the brakes are released then you should be able to move your wheelchair easily without any noise and directional stability. If you notice any unusual braking performance, inform at once your speciality retailer and withdraw the wheelchair from circulation.
- the intactness and cleanliness of the seat and back covering. If it is dirty you can clean it according to the cleaning instructions. If it is damaged, get in touch with your speciality retailer.
- the folding mechanism and all moveable parts on free movement and silent functioning. Squeaking sounds are a sign of partial damage and should be taken care of by the speciality retailer.
- the intactness of all screw joints and rivet connections.

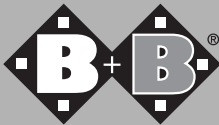

8. Repair & maintenance instructions

It is recommended that the S-Eco 300 wheelchair is subjected to a performance test by the speciality retailer at least once a year. If there are malfunctions or defects, the wheelchair must be taken to the medical supply store or the speciality retailer to be overhauled and repaired. You can find a partner in your neighbourhood if you call our customer service number: +49 (0)700/6000 7070.



On request the speciality retailer will have the necessary information and documents at his disposal.

9. Disposal



If you decide not to use your S-Eco 300 wheelchair any further and want it to be disposed, get in touch with your speciality retailer. If you want to deal with this matter on your own, contact your local waste management organization to find out the disposal rules of your place of residence.

10. Passing on the wheelchair



When passing on the wheelchair please do not forget to hand over to the new user all the necessary technical documents which are important for safe usage. The wheelchair must be checked and according to the maintenance plan must be flawless.

11. Maintenance

A maintenance plan can be provided by our customer service.

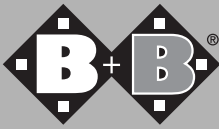

12. Guarantee

Guarantee items refer to all defects of the product which can demonstrably be referred to material defect or manufacturing defect. If there are complaints you have to provide a completed certificate of guarantee. For our wheelchair S-Eco 300 we offer a guarantee of 5 years for frame parts. We offer a 2 year guarantee for all the other parts.



Non-observance of the operating instructions as well as improper carried out maintenance jobs and technical changes, adaptations without the permission of the Bischoff & Bischoff company lead to guarantee loss and product liability in general.

If you have any questions our B & B customer service is ready to answer them. The phone number is +49 (0)700/6000 7070.

Warranty certificate

(Please note our general business terms and conditions)

Model: S-Eco 300

Model number:

Serial number:*

(must be inscribed by the retailer)

Speciality retailer:

Date and Seal

* Information signs can be found on the side frames.

Bischoff & Bischoff GmbH

Becker-Goering-Strasse 13 • D-76307 Karlsbad

Tel.: +49 700/6000 7070 • Fax: +49 700/6000 8080

www.bischoff-bischoff.com

info@bischoff-bischoff.de

